

PERKO®

FIVE YEAR LIMITED WARRANTY

PERKO, INC. (PERKO) warrants to the original consumer-purchaser that PERKO'S consumer products will be free from defective materials or workmanship, and that the PERKOPLATE/PERKO-KOTE Finish will remain corrosion-free under normal use and service, for a period of five (5) years from the original purchase date. Products installed as original equipment by a boat builder or manufacturer are limited to one (1) year or the duration of the manufacturer's general accessory warranty, whichever is longer.

ALL IMPLIED WARRANTIES, INCLUDING MERCHANTABILITY, ARE ALSO LIMITED IN DURATION TO THE FIVE YEAR PERIOD FROM THE ORIGINAL PURCHASE DATE.

PERKO SHALL NOT BE LIABLE FOR LOSS OF USE OF ANY OF ITS CONSUMER PRODUCTS, NOR FOR OTHER INCIDENTAL OR CONSEQUENTIAL COSTS, EXPENSES, OR DAMAGES INCURRED BY THE ORIGINAL CONSUMER-PURCHASER OR BY ANY OTHER PERSON.

SOME STATES DO NOT ALLOW LIMITATIONS ON HOW LONG AN IMPLIED WARRANTY LASTS, SO THE ABOVE LIMITATION MAY OR MAY NOT APPLY TO YOU. SOME STATES DO NOT ALLOW THE EXCLUSION OR LIMITATION OF INCIDENTAL OR CONSEQUENTIAL DAMAGES, SO THE ABOVE LIMITATION OR EXCLUSION MAY OR MAY NOT APPLY TO YOU.

This warranty is void if the consumer product warranted has been damaged by accident or unreasonable use, neglect, improper service or other cause not arising out of defects in material or workmanship. Excluded from this warranty are Electric Light Bulbs (lamps), Sealed Beam Units and Fuses.

During the warranty period, your PERKO product will either be repaired or it will be replaced with a like product (at PERKO's option) without charge to the original consumer-purchaser, when returned prepaid and insured, with proof-of-purchase date to PERKO at the address shown below. In the event of replacement, the replacement product will continue the warranty of the original product, or ninety (90) days, whichever is longer.

PERKO does not authorize any person or company to create for it any other obligation or liability in connection with any of its products.

PERKO, INC.

16490 N.W. 13TH AVENUE • MIAMI, FL 33169-5707 • www.perko.com

PERKO®



Fig. 8521 Series Battery Selector Switch Cup Mount Installation Instructions



Fig. 8521



Front View Installed



Back View Installed

Catalog Numbers:
8521C (Bulk with Cup)
8521DPC

WARNING: Cancer, and other reproductive harm (can expose you to lead). For more information go to www.P65Warnings.ca.gov.

**FIG. 8521 BATTERY SWITCH - CUP MOUNT
INSTALLATION AND OPERATING INSTRUCTIONS**

For use with alternators and generators rated 6-50 V.D.C. Switch rating: 140 Amps Continuous, 200 Amps 5 Minute Intermittent, 250 Amps 30 Second Start.

All wiring to the switch shall be performed by a QUALIFIED MARINE ELECTRICIAN, and in accordance with the "Fire Protection Standard For Motor Craft", N.F.P.A.* No. 302, The Standards of the American Boat and Yacht Council, Inc.*, and the U.S.C.G.* Safety Standards for Boat Electrical Systems (33 CFR 183).

CAUTION: (1) Make sure connections at terminals No.1 and No. 2 are of the same polarity.
(2) Always STOP engines before switching to "OFF" position.

Note: Actuator keys are removable when in the "Off" position for added security.
Replacement key Cat. No. 8521DP0KEY



* The above referenced standards can be obtained from:

- | | | |
|---|--|--|
| 1. American Boat & Yacht Council, Inc.
613 Third Street, Suite 10
Annapolis, MD 21403 | 2. U.S. Coast Guard
Washington, D.C. 20593
(or your local C.G. office) | 3. N.F.P.A.
1 Batterymarch Park
Quincy, MA 02269 |
|---|--|--|

The following diagram illustrates a typical installation:

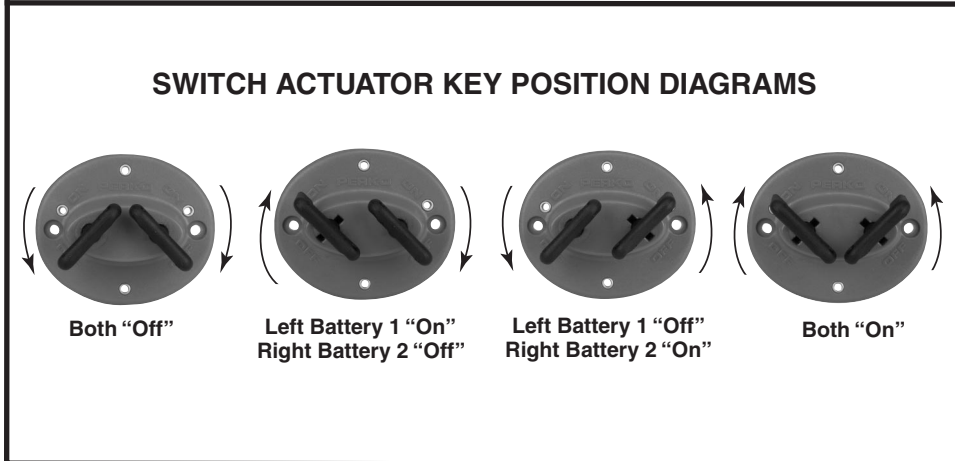
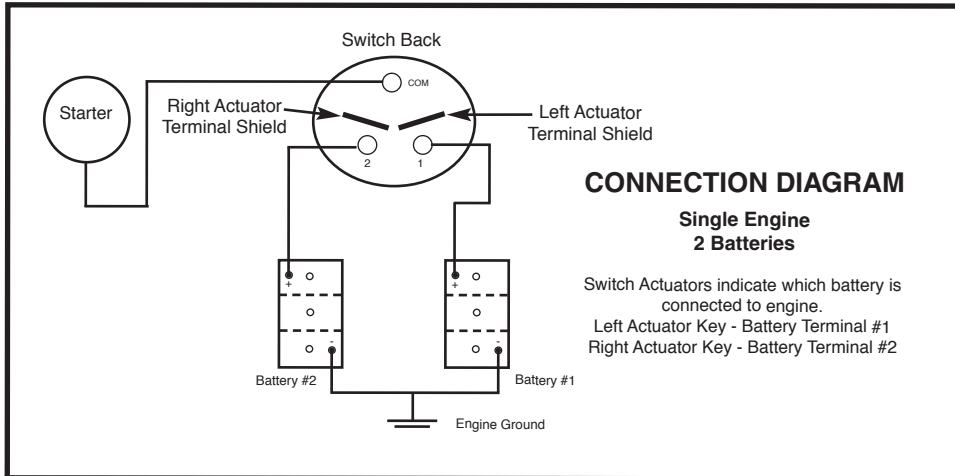

Cup Mount Installation Instructions

1. Locate switch to keep battery cables short as possible.
2. If switch is to be mounted in an area subject to corrosion, it is recommended that a liquid electrical coating be applied to the terminal connections.
3. Cut out the mounting template and tape on mounting surface
4. First drill a 4" diameter hole for the cup as indicated.
5. Next drill four pilot holes for #6 mounting screws.
6. Mount cup and switch to the mounting surface with four #6 screws (not included).
7. Attach the wires to the 3/8 inch terminal studs as indicated in the connection diagram. Torque terminal nuts to 15 ft-lbs. If the switch is installed in a location where the electrical terminals are exposed to possible contact, use terminal boots to cover the exposed terminals.

MOUNTING TEMPLATE

